

R&S® PR100

Portable Receiver

On-site radiomonitoring from 9 kHz to 7.5 GHz

4TECT

ООО «4ТЕСТ»

Телефон: +7 (499) 685-4444

info@4test.ru

www.4test.ru



R&S®PR100

Portable Receiver

At a glance

The R&S®PR100 portable receiver has been specifically designed for radiomonitoring applications in the field. The receiver's functions and control concept have been optimized for monitoring tasks. In addition, it can be used for a variety of other applications.

The R&S®PR100 operates in a wide frequency range from 9 kHz to 7.5 GHz. Whether used for monitoring emissions, detecting interference or locating miniature transmitters, the receiver always combines high mobility with maximum operating ease. The receiver and the R&S®HE400 handheld directional antenna together form a compact receiving system. The receiver can also be used in conjunction with other antennas, e.g. broadband omnidirectional antennas.

Despite its compact design, the R&S®PR100 offers a wide range of functions otherwise available only in equipment in higher price segments. Its favorable price/performance ratio makes it an indispensable instrument for all radiomonitoring tasks where high mobility and cost-efficiency are crucial.

Featuring compact size and low weight, the R&S®PR100 is ideal for use in places that cannot be accessed with a vehicle. Its low power consumption allows the receiver to operate for up to four hours on a single battery charge. The lithium-ion battery can be exchanged in a matter of seconds without any tools. The current instrument settings are automatically written to the internal memory when the receiver is switched off.

Key facts

- Fast panorama scan across the entire frequency range from 9 kHz to 7.5 GHz
- 10 MHz IF spectrum and demodulation with bandwidths from 150 Hz to 500 kHz
- Spectrum and spectrogram (waterfall) display on 6.5" color screen
- Storage of measurement data to receiver's built-in SD card
- LAN interface for remote control and data output
- Ergonomic and rugged design for portable use
- Low weight: 3.5 kg including battery
- Manual location of emissions with the R&S®HE400 handheld directional antenna (9 kHz to 7.5 GHz)
- Automatic location of emissions with direction finding algorithms (20 MHz to 6 GHz)
- Display of digital maps on the R&S®PR100; triangulation based on multiple, manually or automatically determined DF results



The R&S®PR100 with the R&S®HE400 handheld directional antenna: The antenna offers a wide range of optional antenna modules covering the full frequency range from 9 kHz to 7.5 GHz. The preamplifier is accommodated in the grip piece.

R&S®PR100

Portable Receiver

Applications

Interference detection and location in professional radio networks

- ▮ Reliable detection of radio interference caused, for example, by defective electronic equipment
- ▮ Fast and effective elimination of interference sources, e.g. at airports

▷ [page 5](#)

Monitoring of user-specific radio services

- ▮ Monitoring of a large number of radio services with different scan modes
- ▮ Monitoring of an organization's own emissions in an assigned service band
- ▮ Occupied bandwidth measurements to observe frequency band usage

▷ [page 6](#)

Homing of emergency signals

- ▮ Location of source of emergency call with the R&S®HE400 handheld directional antenna
- ▮ Tone function for source location in difficult terrain

▷ [page 7](#)

Location of improvised explosive devices (IED)

- ▮ Detection of IEDs even when they are in standby mode
- ▮ Homing of IEDs with the R&S®HE400 handheld directional antenna
- ▮ Low weight and long battery operating time for mobile applications

▷ [page 8](#)

Mobile tracking of miniature transmitters

- ▮ Detection of bugs, e.g. in conference rooms
- ▮ Location of bugs with the R&S®HE400 handheld directional antenna

▷ [page 9](#)

Triangulation to locate signal sources in manual DF mode

- ▮ Manual direction finding of a signal source with the R&S®HE400 handheld directional antenna
- ▮ Triangulation based on multiple, manually determined DF results
- ▮ Display of results on a digital map loaded in the R&S®PR100

▷ [page 10](#)

Triangulation to locate signal sources in automatic DF mode

- ▮ Automatic direction finding of a signal source with the R&S®PR100-DF option
- ▮ Triangulation based on multiple, automatically determined DF results
- ▮ Display of results on a digital map loaded in the R&S®PR100

▷ [page 12](#)

Detection of pulsed signals and superimposed transmission

- ▮ Capture of short-duration pulses, such as radar emissions
- ▮ Wide IF bandwidth for analysis of short-duration pulses and pulse packets
- ▮ Polychrome spectrum display for indicating relative signal occupancy

▷ [page 13](#)



Top view of the R&S®PR100: maximum operating ease in a compact box.

R&S®PR100

Portable Receiver

Key features

Future-ready investment

- ▮ Wide frequency range and outstanding performance
- ▮ Capable of receiving and processing signals of current and future radio services

▷ [page 15](#)

High receiver sensitivity, high signal resolution

- ▮ State-of-the-art digital signal processing for high receiver sensitivity and detection of extremely weak signals without any loss in processing speed
- ▮ Significantly superior receiver sensitivity and signal resolution (compared with conventional analog receivers)

▷ [page 21](#)

Retrieval of information through demodulation

- ▮ Analog-modulated signals demodulated directly in the receiver; contents audible using headphones or built-in loudspeaker
- ▮ Digitally modulated signals converted to the baseband using I/Q demodulation and stored in the receiver or exported via LAN
- ▮ Online and offline analysis of digitally modulated signals, e.g. with the R&S®CA100 software

Monitoring receiver and mobile data memory in a single unit

- ▮ Collected information written directly to the receiver's built-in SD card
- ▮ Offline analysis of data recording during monitoring

Efficient operation via remote control

- ▮ Full remote control via LAN interface (SCPI commands to IEEE 488.2)
- ▮ Efficient, remote receiver operation, e.g. in unattended monitoring stations
- ▮ R&S®PR100-Control remote control software from the R&S®RAMON software family included

▷ [page 19](#)

Battery operation for mobile use

- ▮ Low weight: 3.5 kg including battery
- ▮ Long battery-powered operation: approx. 4 hours

Intuitive, simple operation

- ▮ Short learning curve due to straightforward menu structure and simple operation
- ▮ Large 6.5" color display for signal analysis

▷ [page 17](#)

Interference detection and location in professional radio networks

Its compact design and wide range of special functions make the R&S®PR100 an ideal choice for tracking all types of radio interference.

Reliable detection of radio interference caused, for example, by defective electronic equipment

To master these tasks, the R&S®PR100 includes special functions such as selectable measurement time and continuous or periodic level output. Since these functions are also effective in the panorama scan mode, even non-periodic interferers, which are otherwise difficult to recognize due to their irregular appearance in a quickly changing spectrum, can be easily detected.

Fast and effective elimination of interference sources, e.g. at airports

Using the R&S®HE400 handheld directional antenna together with the R&S®PR100 portable receiver, the source of an interference can be quickly and reliably located and eliminated. This capability is especially important in security-critical radio scenarios (e.g. air traffic control, ATC) as it prevents high failure costs for the service provider. The fast panorama scan is ideal for this task.

In the panorama scan mode, the frequency range of interest is scanned in steps of max. 10 MHz. An FFT of corresponding width is calculated for each step. Maximum scan speed is achieved by selecting the maximum spacing of 100 kHz between the FFT calculation points.

This provides a quick overview of the spectrum occupancy. Any changes caused by illegal radio services, interference sources, temporary emissions, etc., are easy to recognize. If the user stops the panorama scan, the receiver switches to the audio-monitoring mode. Using the marker function, a signal of interest can be selected, demodulated, and the signal content analyzed.

The step width for the fast panorama scan can be chosen to match the channel spacing of a variety of radio services. The panorama scan provides high scan rates at narrow resolution bandwidths and high sensitivity.



Interference in radiocommunications, e.g. at airports, not only impedes operation – it may even pose a threat to life.

Monitoring of user-specific radio services

The frequency scan mode is mainly intended for monitoring radio services that use fixed channel spacing.

Monitoring of a large number of radio services with different scan modes

In the frequency scan mode, a user-defined frequency range is scanned using fixed channel spacing. The receiver steps through the frequency range of interest and checks every channel to see if any signals are present. If a signal is detected that exceeds the predefined level threshold, the receiver dwells at the corresponding frequency for the set hold time, allowing for the signal to be demodulated and processed. In the case of analog modulation, the demodulated signal can be monitored via the loudspeaker or headphones.

In the memory scan mode, predefined channels stored in memory locations are consecutively scanned and analyzed to see if any signals are present. The R&S®PR100 offers 1024 user-definable memory locations. Receive parameters can be assigned separately to each memory location.

The memory scan mode is especially useful for scanning individual frequencies that do not have fixed channel spacing or that use different demodulation modes and bandwidths. The memory scan mode offers the user a greater degree of freedom than the frequency scan mode.

Monitoring of an organization's own emissions in an assigned service band

- Shortwave communications
- Tactical communications
- Air traffic control (ATC)
- TETRA
- Demodulation, e.g. of broadband TETRA with 200 kHz channel bandwidth
- 433 MHz/868 MHz/2.4 GHz ISM bands
- GSM 850/900/1800/1900
- AMPS/DECT/UMTS
- Bluetooth®/WLAN
- WiMAX™/Wi-Fi
- RFID/ZigBee

Occupied bandwidth measurements to observe frequency band usage

When a modulated signal is approved for licensed frequency bands, it must be ensured that this signal conforms to the defined bandwidth. The R&S®PR100 occupied bandwidth measurements functionality, featuring the % and the x-dB methods, offers two ITU-compliant techniques (in line with ITU-R SM.443) to determine the bandwidth actually used by an emission. In addition, the channel power for the identified bandwidth is calculated and displayed. An integrated function makes it possible to identify the bandwidth's long-term peak values even over a period of days.



Smooth operation of an organization's own radio networks is vital to ensure operational readiness – not only for government operators.

The Bluetooth® word mark and logos are registered trademarks owned by Bluetooth SIG, Inc. and any use of such marks by Rohde&Schwarz is under license. WiMAX Forum is a registered trademark of the WiMAX Forum. WiMAX, the WiMAX Forum logo, WiMAX Forum Certified, and the WiMAX Forum Certified logo are trademarks of the WiMAX Forum.

Homing of emergency signals

Transmitters can be tracked not only visually by displaying the received signal level or the spectrum, but also acoustically with the tone function.

Location of source of emergency call with the R&S®HE400 handheld directional antenna

For example, if an emergency transmitter has been identified at a specific frequency, the user can activate the tone function in order to locate the transmitter. This function causes the receiver to output a whistling tone whose pitch varies with the level of the signal received. The signal level, in turn, varies as the user changes position or points the antenna in various directions.

Tone function for source location in difficult terrain

The acoustic level indication allows the user to fully concentrate on the terrain and on tracking the transmitter as there is no need to continuously monitor the receiver display.



When a person in distress has been located with the R&S®PR100 and the R&S®HE400, the position information is immediately forwarded to the rescue team.

Location of improvised explosive devices (IED)

By approaching the signal source, the R&S®PR100 can locate even extremely weak signals in difficult terrain.

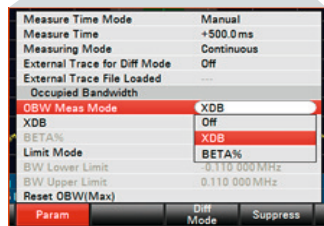
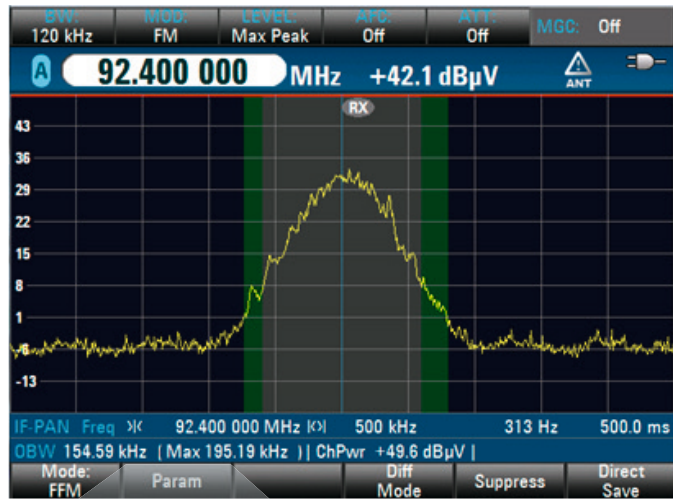

The occupied bandwidth of a signal can easily be measured. The results are displayed as numerical values and highlighted areas in the spectrum display.

Detection of IEDs even when they are in standby mode

For example, the oscillator reradiation of an IED (once the frequency is known) is visible on the display of the R&S®PR100 even if the IED device is operating in the receive-only mode. The receiver of a remote detonation device leaves traces in the frequency spectrum even in standby mode. Oscillator reradiation and other spurious effects caused by remote control electronics are unintended emissions. They tend to occur more frequently in semi-professional equipment such as is used to detonate improvised explosive devices.

Homing of IEDs with the R&S®HE400 handheld directional antenna

The R&S®PR100 receiver's wide frequency range proves very helpful when it comes to detecting these emissions, since the exact spectral range is not known when the search begins. The receiver features a preselection function, which yields valuable results even in environments characterized by strong noise or strong signal levels close to the frequency of interest. The preselection function limits the signal sum level to be handled by the receiver. As a result, it provides effective signal detection in battle-field scenarios that are highly loaded in terms of frequency and level.

Low weight and long battery operating time for mobile applications

Weighing only about 3.5 kg, the receiver can be easily carried in a convenient chest strap. The R&S®PR100 operates for an average period of four hours on a single battery charge. This makes it suitable for all kinds of portable radiomonitoring applications.



Tracking telltale signals with the R&S®PR100 and the R&S®HE400 active directional antenna.

Mobile tracking of miniature transmitters

The R&S®PR100 portable receiver offers high mobility plus a convenient carrying strap, making it perfectly suited for all kinds of mobile applications.

Detection of bugs, e.g. in conference rooms

The R&S®PR100 can easily detect all types of miniature transmitters (bugs) as it approaches them. Its wide frequency range from 9 kHz to 7.5 GHz covers the frequency bands of the majority of miniature transmitters used today. For frequencies above 7.5 GHz, the R&S®HF907DC frequency-converting, portable directional antenna can be used to expand the receive frequency range up to 18 GHz.

Location of bugs with the R&S®HE400 handheld directional antenna

The R&S®PR100 offers a differential mode function to facilitate signal detection. The current spectrum can be stored as a reference spectrum by pressing the associated key during the panorama scan. The receiver then displays any signal variations as a differential spectrum relative to the reference spectrum. Any new or changed signals can be recognized at a glance. The intensity of the signals emitted is strongly dependent on direction, especially in the close vicinity of miniature transmitters. The differential mode function is therefore a valuable aid in tracking these transmitters.

Another efficient tool for locating miniature transmitters is the tone function of the R&S®PR100. This function outputs a whistling tone whose pitch varies with the level of the signal received. This facilitates locating the signal source because the user does not have to continuously monitor the receiver display.

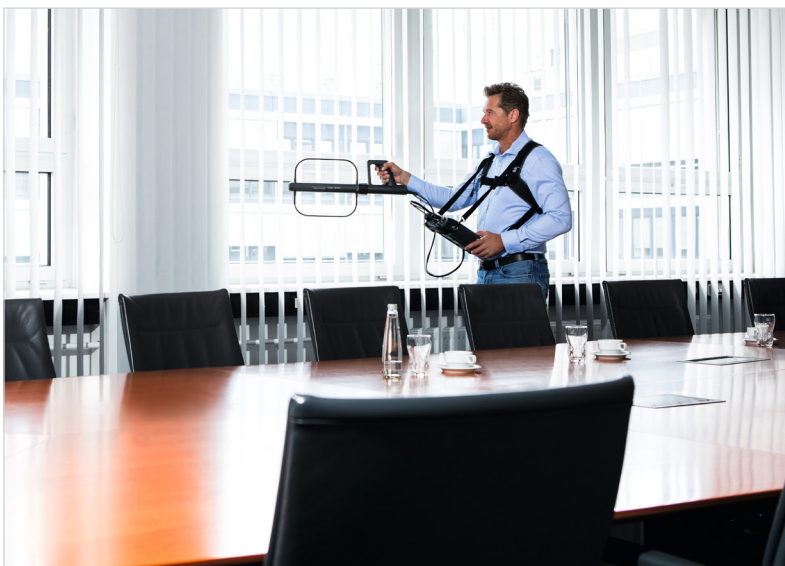

Finding bugs with the R&S®PR100 and the R&S®HE400 handheld directional antenna.

Triangulation to locate signal sources in manual DF mode

Manual direction finding of a signal source with the R&S®HE400 handheld directional antenna

The desired direction information relative to north is obtained by manually lining up the R&S®HE400 in the receive direction where the signal is strongest. This information is shown on a compass rose on the R&S®PR100. Combining this information with the receiver's GPS position gives the user clear position and direction information that can be used to approximate the location of the signal source. Several DF results can be combined to more exactly pinpoint the source of the signal.

Triangulation based on multiple, manually determined DF results

All saved DF results are available in list form. The user selects results from this list to carry out triangulation. The triangulation result, i.e. the strongest signal source, and the calculated error radius are displayed on a digital map loaded in the R&S®PR100. The location of the signal source is now known, and suitable measures can be taken to, for example, render the interfering electrical device inoperative and eliminate the interference.

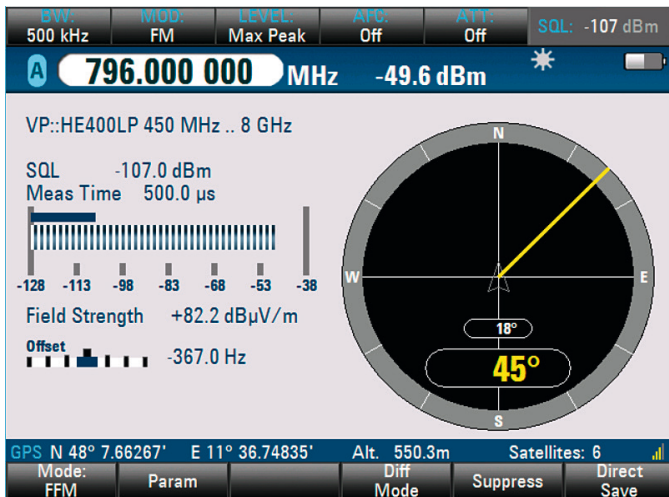

Direction finding of a signal source with the R&S®HE400 handheld directional antenna.

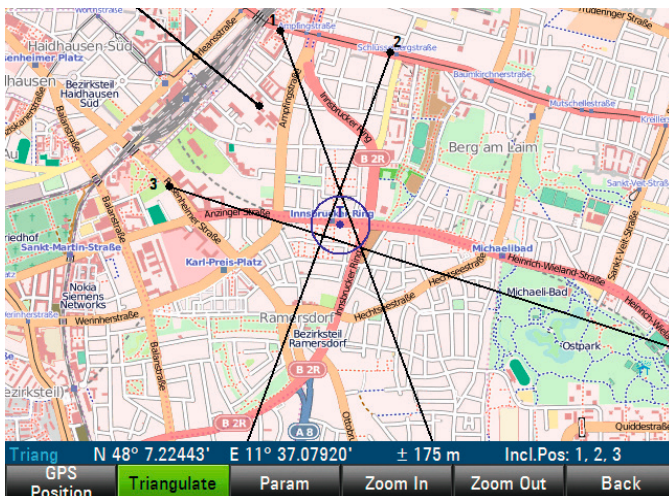

Triangulation based on multiple DF results.

Display of results on a digital map loaded in the R&S®PR100

Maps for the R&S®PR100 can be downloaded free of charge at www.openstreetmap.org. The R&S®OpenStreetMapWizard (OSMWizard) software makes downloading maps easy. Users simply select a map section, set the desired zoom factor and download the map to a PC. They then copy the files from the PC to the R&S®PR100 SD card, where the files are now available for field use.



The R&S®HE400 handheld directional antenna including GPS module and electronic compass, connected to the R&S®PR100.

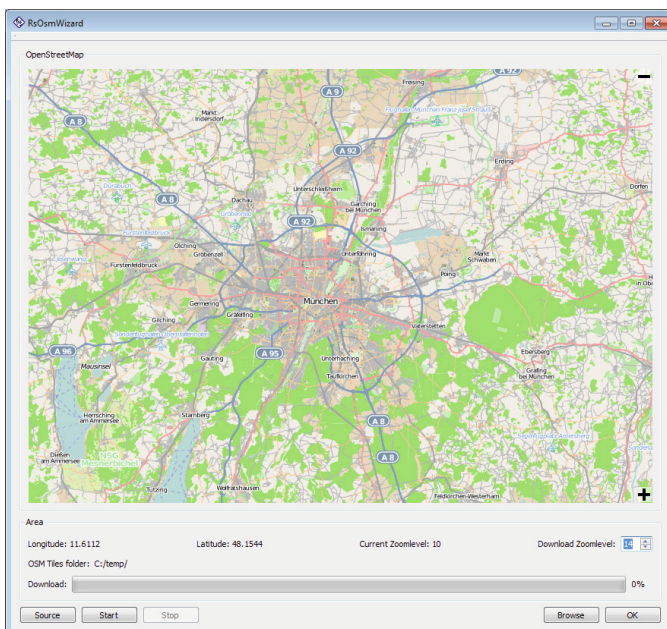

Maps can be downloaded at www.openstreetmap.org.

OpenStreetMap (OSM)

OpenStreetMap (OSM) is a user-editable world map that is available at the following Internet address:
<http://www.openstreetmap.org/>

OSM is a wiki project in which users can participate by uploading and editing geographical information such as GPS tracking data or the course of a road or river. This world map is growing daily.

OpenStreetMap data can be used freely under the terms of the Creative Commons Attribution-ShareAlike 2.0 license.

Triangulation to locate signal sources in automatic DF mode

High-precision, wideband DF methods in a compact package

The R&S®PR100-DF upgrade kit turns the R&S®PR100 into a powerful and convenient portable direction finder. Using the patented Rohde&Schwarz single-channel correlative interferometer DF method, it provides DF accuracy and immunity to reflections comparable to that of direction finders with two or more receive paths – without requiring additional hardware. The integrated upgrade kit covers a wide direction finding range of 20 MHz to 6 GHz. The advantages of the R&S®PR100 combined with the proven single-channel DF method provides users with a compact, battery-operated solution that is ideal for applications requiring flexibility and mobility – e.g. when tracking short-duration signals such as push-to-talk communications.



The R&S®PR100 with integrated R&S®PR100-DF upgrade kit in DF mode.

Installing the portable mobile direction finder in a commercial vehicle only takes a few minutes thanks to compact DF antennas with an integrated GPS receiver, electronic compass and an optional magnetic base adapter.

Automatic direction finding of a signal source with the R&S®ADD107 or R&S®ADD207 compact DF antenna

The receiver automatically obtains the desired bearing information relative to north. This information is shown on a compass rose on the R&S®PR100. When equipped with the R&S®PR100-GPS option, this information is combined with the receiver's GPS position to provide clear position and direction information on a map. The R&S®PR100-GPS option uses running fix and the integrated triangulation function (including calculation of the error radius) to allow users to combine several DF results and more accurately pinpoint the source of the signal.



Manual triangulation of the automatically determined DF results and display of the overlaid result on a map.

Detection of pulsed signals and superimposed transmission

Short-time signals cannot be detected with conventional measurement tools based on averaging signal samples over a period of time. The same limitation applies whenever several pulsed signals occupy the same frequency range. A regular detector cannot separate those signals. The R&S®PR100-PC option eliminates those limitations.

The polychrome spectrum display separates superimposed, pulsed signals that cannot be differentiated using conventional methods (e.g. spectrum, waterfall, max. hold). To differentiate complex signal scenarios of this kind, the receiver analyzes the relative occurrence of each individual frequency/level bin and displays the results versus frequency in a color-coded diagram. Signals that occur more frequently can be simply and clearly separated from less frequent signals by their respective color displayed in the spectrum. The polychrome spectrum is very useful for signal separation, for example to identify pulsed interfering signals superimposed on pulsed wanted signals (e.g. GSM, DECT). This also helps to easily differentiate between signals types, e.g. burst or continuous as indicated by colors.

Short-time signals with a low duty cycle are normally lost in the averaging process or have a very low POI in clear/write modes. With the polychrome spectrum display those pulses can be detected in realtime, as up to 50 000 spectra per second are processed by the dedicated FPGA architecture.

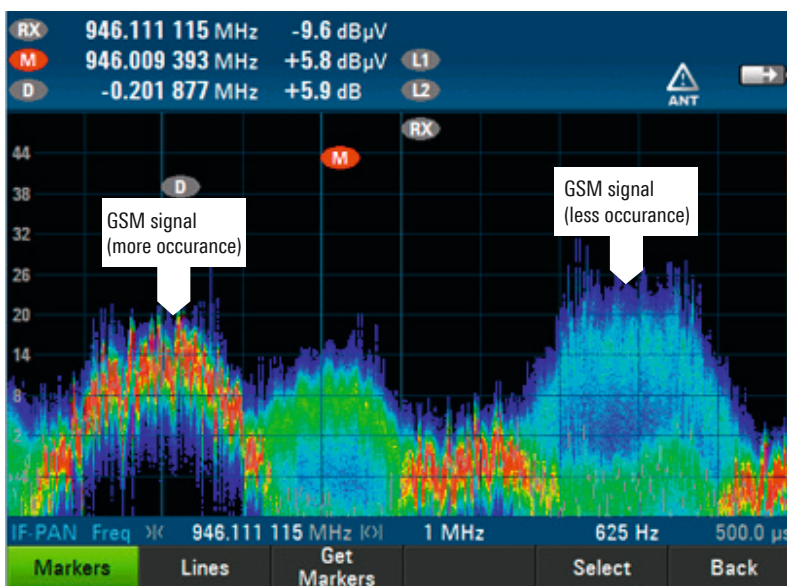

Superimposed, pulsed signals (e.g. GSM-900 downlink segment) are displayed in different colors based on how often they occur and can be more easily analyzed than with max. hold processing.

Main functional features of the R&S®PR100-PC polychrome spectrum display option

Display of results in realtime

Calculation of the polychrome spectrum is fully implemented with FPGA technology. The results are therefore displayed in realtime. Time-consuming postprocessing of recorded signal samples is not necessary. The convenient handling of realtime processing allows the operator to focus on the tasks ahead.

Easy to operate

The operator activates the polychrome spectrum display by simply pressing a button. All features of the normal spectrum display (such as markers, level measurement) are available. The settings for the R&S®PR100-PC option are easy and intuitive as well as flexible and powerful enough to optimize the polychrome spectrum display for a wide range of signals.

High probability of intercept (POI)

The R&S®PR100-PC option offers a high POI for short-time pulsed signals. With the integrated dedicated POI mode, pulses with a duration of only 60 μ s can be reliably detected with full level accuracy. Combined with the gap-less processing of the R&S®PR100, this offers unparalleled performance.

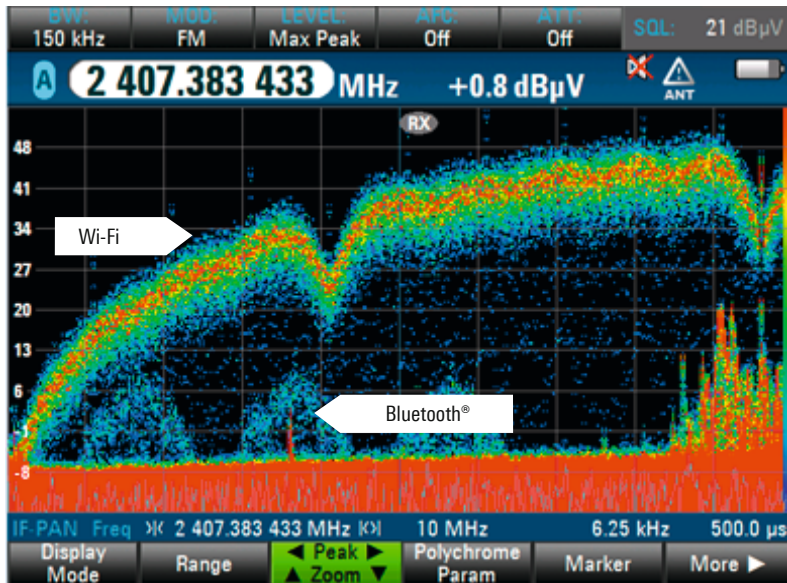

A low-amplitude pulsed signal (Bluetooth®) superimposed by a pulsed signal with higher amplitude (WLAN) can only be seen by using the polychrome spectrum.

Future-ready investment

The receiver's wide frequency range and outstanding performance make it a future-ready investment. The R&S®PR100 is capable of receiving and processing signals of current and future radio services.

High receiver sensitivity, high signal resolution

Using state-of-the-art digital signal processing, the R&S®PR100 can receive signals with high sensitivity and detect even extremely weak signals without any loss in processing speed. The receiver's sensitivity and signal resolution are clearly superior to those of a conventional analog receiver.

Retrieval of information through demodulation

Signals with analog modulation can be demodulated in the receiver. The signal can be heard through the built-in loudspeaker or headphones. Complex baseband signals can be recorded internally or externally for offline analysis. The PC-based R&S®CA100 analysis software is available for both online and offline signal analysis. The data to be analyzed is transferred to a PC via LAN. The demodulation bandwidth can be selected independently of the IF bandwidth.

Monitoring receiver and mobile data memory in a single unit

The receiver provides the following internal storage media and functions for recording measured data:

- 64 Mbyte RAM for recording I/Q data up to 500 kHz bandwidth or audio data up to 12.5 kHz bandwidth
- 4 Gbyte SD card for storing recorded I/Q data, audio data, spectra and measured data
- External SD card reader to read out SD card
- Digital audio data recorded in WAV format, measured values in CSV format; screenshots saved in PNG format to SD card
- Digital data available online at the LAN interface; can be recorded externally (e.g. on a PC hard disk)
- Data buffering not necessary



The R&S®PR100 with fold-out stand for desktop use.

Efficient operation via remote control

The receiver can be fully remotely controlled via its LAN interface. This allows efficient, remote operation of the receiver, e.g. in unattended monitoring stations. The LAN interface is capable of handling the maximum data transfer rate. The protocol of the LAN interface is compliant with the IEEE 488.2 SCPI standard.

Battery operation for mobile use

- Low weight: 3.5 kg including battery
- Long battery-powered operation: approx. four hours in RX mode, approx. two hours in DF mode

Frequency range extendable up to 18 GHz

The R&S®HF907DC SHF directional antenna with downconverter extends the receiving frequency range of the portable receiver up to 18 GHz. The user can then take advantage of the rich feature set of the R&S®PR100 up to 18 GHz, for example to detect interference caused by directional radio link communications.

Specifications in brief of the R&S®HF907DC		
Frequency range	band 1	7.5 GHz to 12.5 GHz
	band 2	12.5 GHz to 18 GHz
Polarization	manual setting	horizontal, vertical or 45°
VSWR		typ. 2.5
Impedance		50 Ω
RF connector		N type, female
Weight	including rechargeable battery	approx. 3.5 kg



R&S®HF907DC SHF directional antenna with downconverter.



R&S®HF907DC SHF downconverter.

Intuitive, simple operation

The operating concept of the R&S®PR100 meets the requirements placed on a modern radiomonitoring receiver, i.e. all important functions such as demodulation modes and bandwidths can be set directly using clearly labeled keys. Users are quickly able to use the receiver.

The receiver is controlled conveniently via keys and the rotary knob. Clearly structured menus provide quick access to instrument parameters and functions.

Results, as well as the spectrum and waterfall diagrams, can be read at a glance on the bright, well-organized 6.5" VGA color display. The backlighting of the display can be dimmed for use in dark surroundings. For use in sunlight, a special black-and-white display mode is available that optimizes contrast.

The IF panorama display facilitates the detailed analysis of a frequency range of interest. The current receive frequency is positioned at the center of the spectrum display. IF bandwidths between 1 kHz and 10 MHz can be selected to suit the task at hand. The average, min. hold and max. hold functions further expand analysis capabilities.

The user can change how the results are displayed to meet the current requirements. Measured data is available in various formats.



All important functions such as demodulation modes and bandwidths can be set directly using clearly labeled keys provided both on the top and on the front of the receiver.

Digital data is output via the LAN interface:

- Complex baseband data (I/Q data) up to 500 kHz bandwidth
- Digital audio data up to 12.5 kHz bandwidth
- Spectra of panorama scan (with maximum update rate)
- Spectra of IF panorama display (with maximum update rate)
- Measured signal levels
- Measured frequency offset values
- Measured field strength values (antenna factors of antenna used must be stored in the receiver)

Analog data is output via the corresponding analog interface:

- Analog audio data via 3.5 mm jack
- 21.4 MHz uncontrolled IF via BNC socket (for receive frequencies from 20 MHz to 7.5 GHz)

The user settings and level indication modes become effective at different points in signal processing. This is explained in greater detail in the “Operating principle” section, which uses block diagrams to describe R&S®PR100 operation.

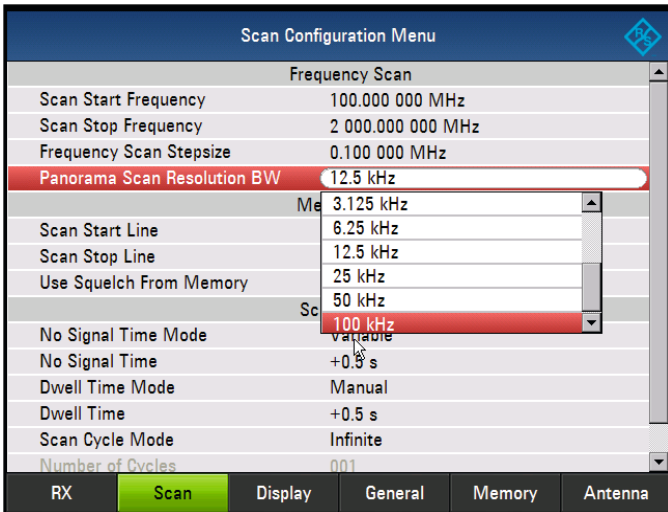

Structure of R&S®PR100 configuration menus.

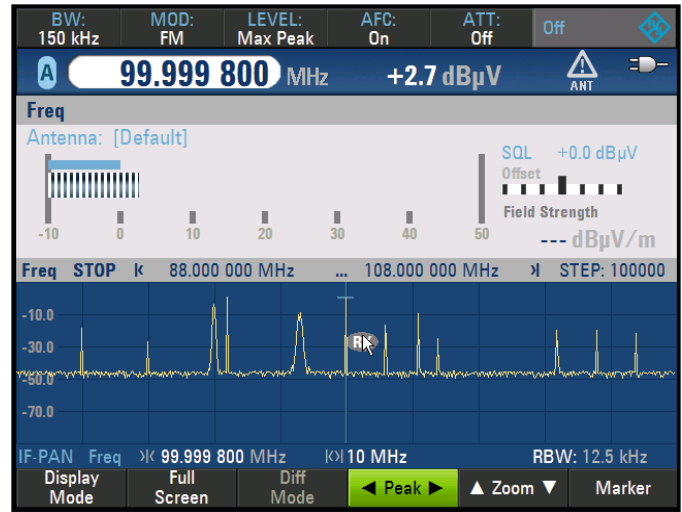

Display of measured level and IF spectrum.

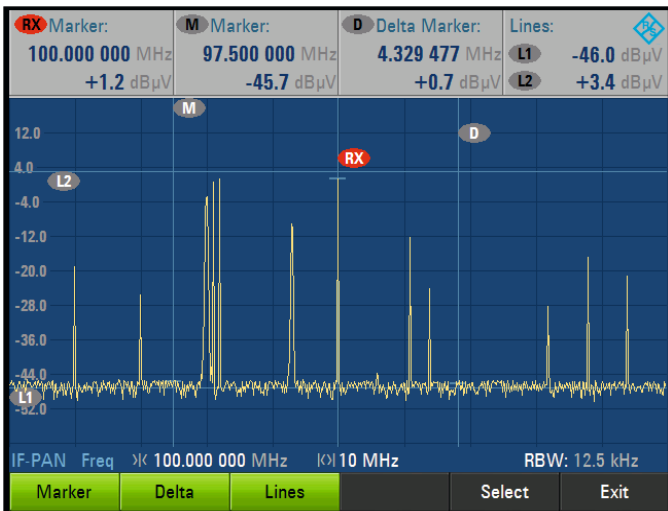

IF spectrum analysis using marker functions.

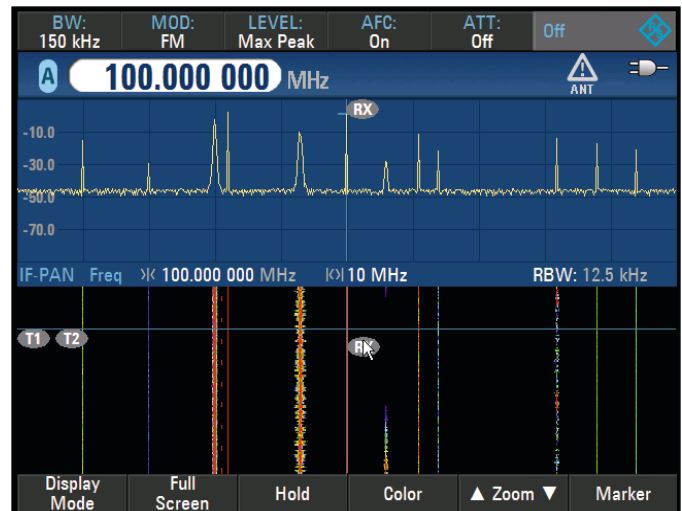

Display of IF spectrum and spectrogram (waterfall display).

Convenient R&S®PR100-Control remote control software

The R&S®PR100-Control remote control software is supplied free of charge with the R&S®PR100. It is part of the R&S®RAMON software family and enables convenient and efficient operation of the receiver from a PC workstation. The software offers a straightforward menu structure and intuitive operation so that training requirements for operating personnel are minimal.

The complete functionality provided by the R&S®PR100 can be controlled using the R&S®PR100-Control software. The graphical user interface enables operation of the receiver with easy-to-read online signal display as well as signal recording and playback. Optional R&S®RAMON software packages are available to significantly expand the range of functions. For example, it is possible to add handover functions to and from additional receivers or direction finders, as well as task, reporting and database functions. R&S®RAMON software components can be used to implement customer-specific radiomonitoring systems – from single, standalone systems to nationwide networked systems.

Major functional features of R&S®RAMON

Fast and simple operation

The main functions can be accessed using shortcuts.

The graphical display of results includes:

- IF spectrum with waterfall diagram
- RF panorama spectrum with waterfall diagram

The user can adapt the colors of the display and the size and arrangement of the windows as required for a specific task or area of application. Easy-to-use measurement functions are available within the diagrams.

Display, storage and playback of spectra and waterfall data

R&S®PR100-Control enables the recording and playback of RF and IF signal spectra. In addition, digital audio data and I/Q baseband data (digital IF) of up to 500 kHz bandwidth can be stored, e.g. for the subsequent analysis of digitally modulated signals.

Buffering of frequency scan data in a ring buffer

Recording in the ring buffer can be stopped by a mouse click. The stored signals are then available in playback mode for analysis.

Frequency list for marking signals

With a mouse click, radio channels can be marked, saved in a list and graphically placed over the spectrum. The frequency list is available for storage and subsequent analysis.

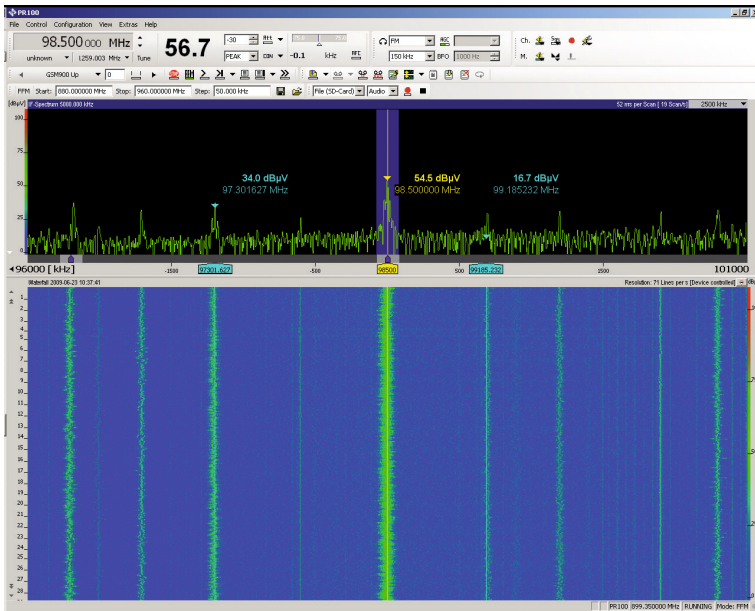

Display of IF spectrum and use of marker function.

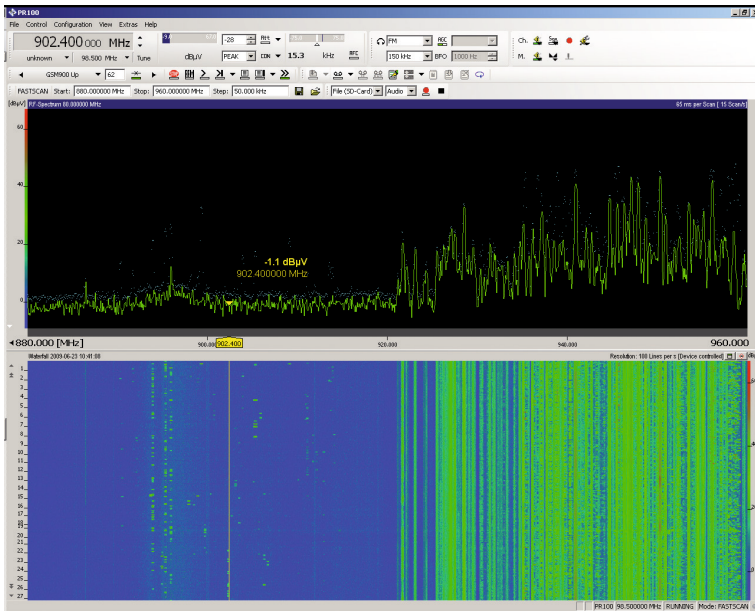

Wideband panorama scan with max. hold function and waterfall diagram.

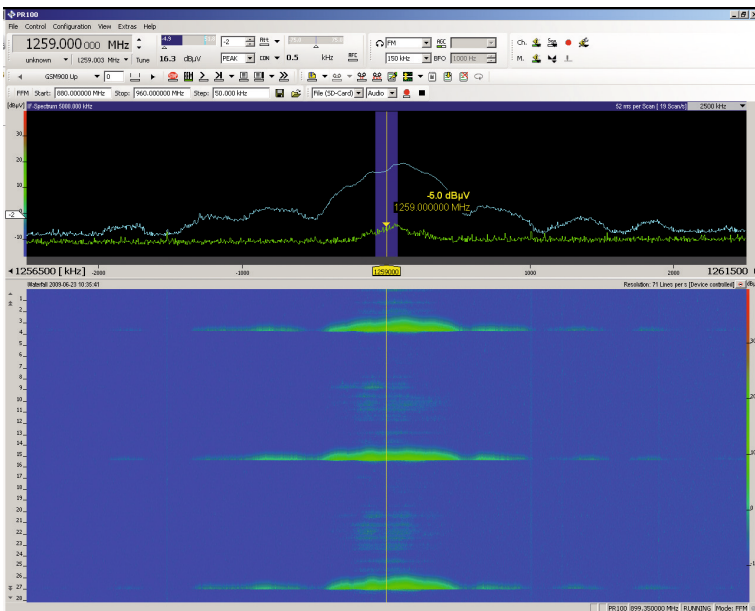

IF spectrum and waterfall diagram of a radar signal from Munich Airport (Germany).

Operating principle

Frontend

Starting from the antenna socket, the frequency in the signal path is limited to 8 GHz. Signal processing then takes place in three paths for three different frequency ranges.

Signals from 9 kHz to 30 MHz are routed via a preamplifier directly to the A/D converter. Signals from 20 MHz to 3.5 GHz are routed to the IF section through the preselection and a preamplifier, or through an attenuator in the case of high signal levels. Both the preselection and the attenuator effectively protect the IF section against overloading. This is particularly important in this frequency range, where the maximum signal sum levels occur. Signals from 3.5 GHz to 8 GHz are routed to the IF section through a preamplifier.

The three-stage IF section processes the signals from 20 MHz to 8 GHz for the subsequent A/D converter. To provide optimum instrument performance, only signals up to 7.5 GHz are processed in the subsequent stages. The uncontrolled 21.4 MHz IF can also be tapped ahead of the A/D converter via a BNC socket on the R&S®PR100 for further external processing.

Digital signal processing

After A/D conversion of the signal, the signal path is split up:

In the first path, the IF spectrum is calculated using a digital downconverter (DDC), a digital bandpass filter and the FFT block. The bandwidth of the bandpass filter can be selected between 1 kHz and 10 MHz. Before the IF spectrum is output on the display or via the LAN interface, results are postprocessed using the average, min. hold or max. hold function as selected by the user.

In the second path, which also includes a DDC and a bandpass filter, the signal is processed for level measurement or demodulation. To process the different signals with optimum signal-to-noise ratio, the receiver contains IF filters with demodulation bandwidths from 150 Hz to 500 kHz, which can be selected independently of the IF bandwidth.

Prior to the level measurement, the absolute value of the level is determined and weighted using the average, max. peak, RMS or sample function, as selected by the user. The measured level is then output on the display or via the LAN interface.

To demodulate analog signals, the complex baseband data passes through the baseband filter, then undergoes automatic gain control (AGC) or manual gain control (MGC) and is finally demodulated in the AM, FM, USB, LSB, ISB, pulse or CW demodulation stages. After the AGC/MGC stage, the complex baseband data (I/Q data) resulting from the digitized signals is directly output for further processing.

Simplified block diagram of the R&S®PR100 frontend

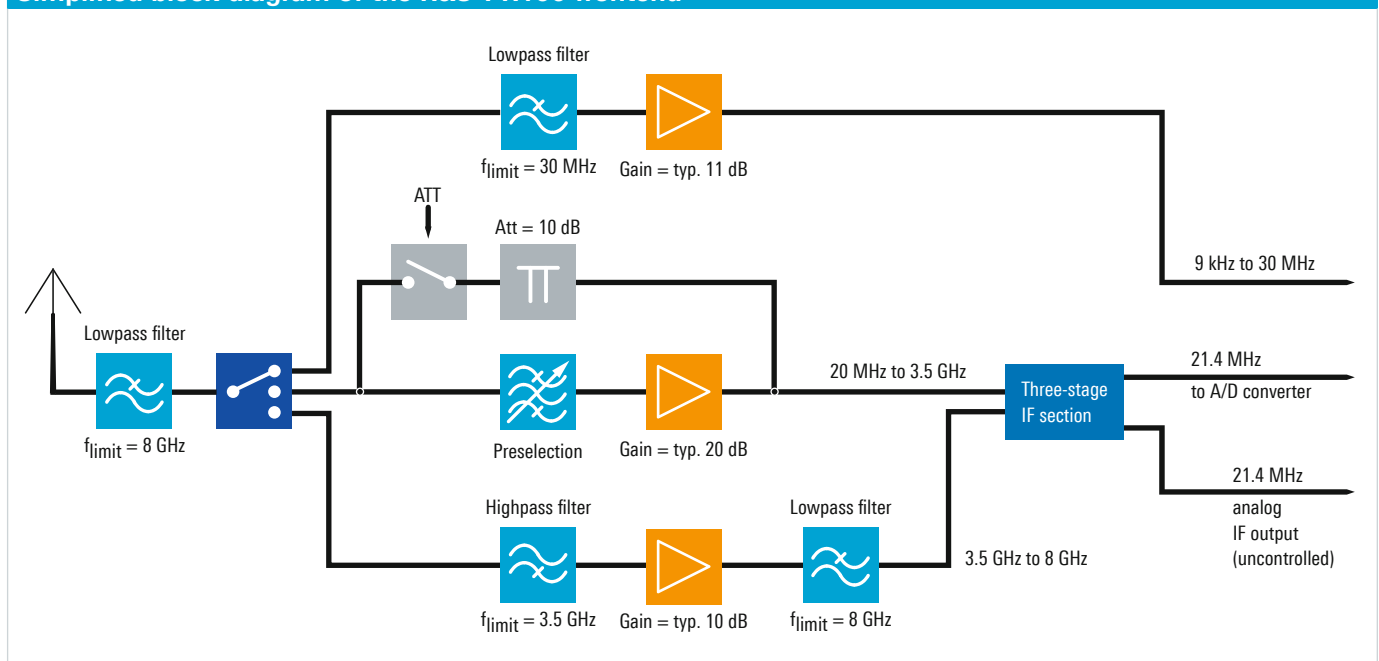

The R&S®PR100 uses an FFT length N of 2048 points to generate the IF spectrum. To calculate these points, the 12.8 kHz sampling band in the above example is divided into 2048 equidistant frequency slices, which are also referred to as bins (see figure “Signal processing for IF spectrum”).

The bandwidth BW_{bin} of the frequency slices is obtained as follows:

$$BW_{bin} = \frac{f_s}{2048} = \frac{12.8 \text{ kHz}}{2048} = 6.25 \text{ Hz}$$

This means that in the above example, only the calculated bandwidth of 6.25 Hz for each bin has to be taken into account as the noise bandwidth in the calculation of the displayed noise level (DNL) in accordance with the formula below (the effect of the window function (Blackman window) of the FFT is not considered here for simplicity's sake):

$$DNL = -174 \text{ dBm} + NF + 10 \cdot \log(BW_{bin}/\text{Hz})$$

The quantity NF represents the overall noise figure of the receiver.

The above example shows that, due to the use of the FFT, the actual resolution bandwidth (RBW) to be taken into account in DNL calculation is clearly smaller (i.e. BW_{bin}) than would be expected for the wide display range of 10 kHz.

Another advantage of the high spectral resolution used in the FFT calculation is that signals located close together (e.g. f_1, f_2, f_3) can be captured and represented in the IF spectrum as discrete signals (see figure “Signal display in IF spectrum”).

If, on an analog receiver, a resolution bandwidth equal to the set IF bandwidth were selected ($RBW = BW_{IF \text{ spectrum}}$), a sum signal f_{sum} would be displayed instead of the three discrete signals f_1, f_2 and f_3 .

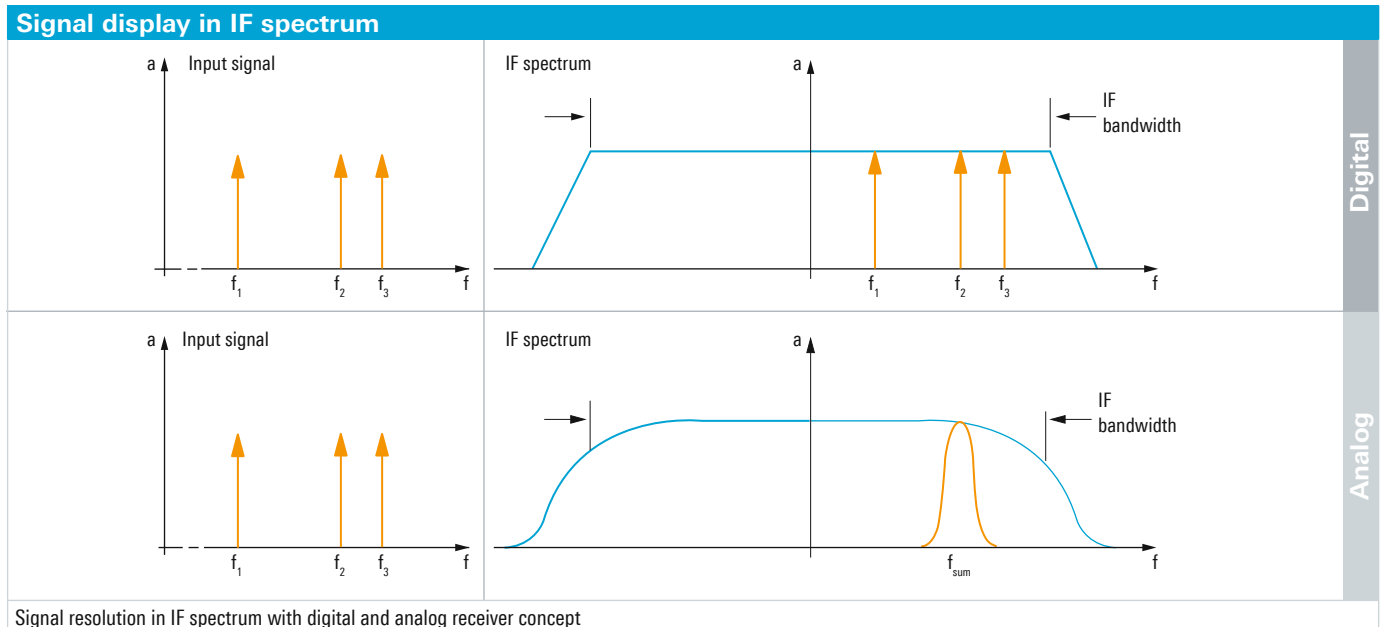
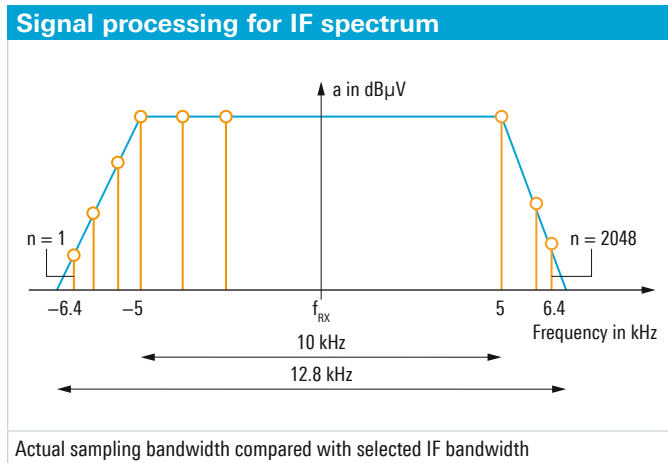

Panorama scan

The receiver's maximum FFT bandwidth of 10 MHz makes it possible to perform extremely fast scans across a wide frequency range (panorama scan). For this purpose, frequency windows of max. 10 MHz width are linked in succession, so that the complete, predefined scan range is traversed (see figure "Signal processing in panorama scan mode"). As is done for the IF spectrum, an FFT is used to process the broad window with a finer resolution.

The width of the frequency window and the FFT length (number of FFT points) are variable and are selected by the receiver.

In the panorama scan mode, the user can select among 12 resolution bandwidths from 125 Hz to 100 kHz. The resolution bandwidth corresponds to the width of the frequency slices (bin width) mentioned on page 23, under "IF spectrum". Based on the selected bin width and start and stop frequency, the R&S®PR100 automatically determines the required FFT length and the width of the frequency window for each scan step. The receiver selects these internal parameters so that the optimum scan speed is achieved for each resolution bandwidth (see figure "Resolution in panorama scan mode").

In the panorama scan mode, the resolution bandwidth of 100 kHz yields the maximum scan speed, while the resolution bandwidth of 125 Hz yields maximum sensitivity.

The resolution bandwidth (bin width) for the panorama scan (selectable between 125 Hz and 100 kHz) therefore corresponds to the resolution bandwidth (BW_{bin}) used in the DNL calculation for the IF spectrum (see DNL formula on page 23, under "IF spectrum"), and can be used for calculating the DNL for the panorama scan. Moreover, the user selects the resolution bandwidth to obtain the desired frequency resolution (see figure "Bin width and channel spacing").

The above explanations show that the use of digital signal processing in a monitoring receiver offers decisive advantages. Extremely high sensitivity (due to very fine resolution) combined with a broad spectral overview and high scan speed significantly increases the probability of intercept in comparison with an analog receiver.

Example: signal processing in panorama scan mode

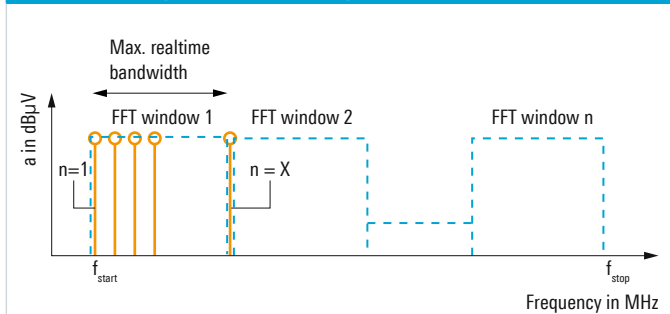

Basic sequence of steps in fast panorama scan mode

Resolution in panorama scan mode

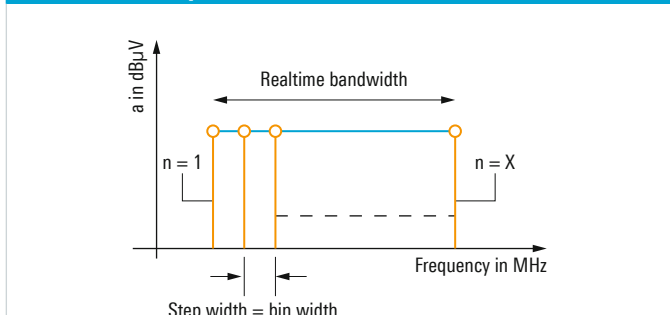

Selection of resolution for panorama scan by varying the bin width

Example: resolution in panorama scan mode

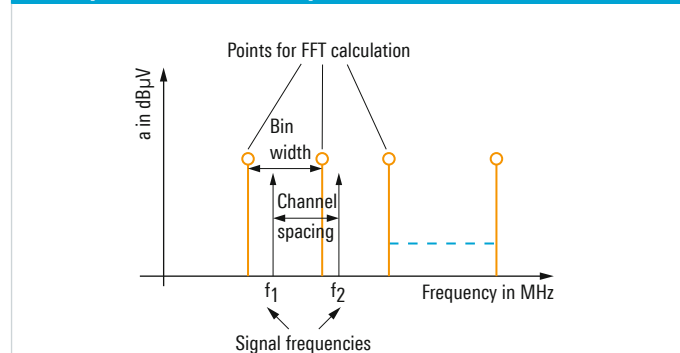

Selection of 12.5 kHz bin width to capture a radio service using 12.5 kHz channel spacing

R&S®HE400 handheld directional antenna

Five different antenna modules from 8.3 kHz to 8 GHz are available. They can be plugged into the antenna handle in order to enable reception of vertically or horizontally polarized signals. The type of module and its orientation is detected by the antenna handle – making it possible to automatically display field-strength values on the R&S®PR100 based on stored antenna factor data.



R&S®HE400HF
HF antenna module.



R&S®HE400VHF
VHF antenna module.



R&S®HE400UWB
UWB antenna module.



R&S®HE400LP
log-periodic antenna module.



R&S®HE400CEL
cellular antenna module.

Portable monitoring and measuring system

The R&S®HE400 handheld directional antenna and the R&S®PR100 portable receiver together form a powerful receiving system for locating transmitters. The portable and lightweight instrument combination can perform measurements in buildings or in rough terrain that even four-wheel-drive vehicles cannot access. The cost-effective monitoring system, featuring position finding and level measurement, offers another decisive advantage: It can be transported and deployed relatively inconspicuously.

Ease of use and control

The R&S®HE400 features trigger and toggle buttons directly on the antenna handle, allowing users to perform all necessary controls – including receiver-configurable trigger actions. Its light weight makes operation fatigue-free. In conjunction with the removable armrest, even long-term surveillance tasks in the field do not stress the user. For long-term monitoring at fixed locations, the antenna can be mounted on a tripod. The connecting thread on the grip piece matches the mounting bolts of conventional camera tripods.

Sensitivity and dynamic range

A built-in, switchable low-noise amplifier (LNA) further enhances system sensitivity at low signal field strength, increasing the probability of intercept (active mode). In the passive mode, the amplifier is bypassed, so that the antenna can also be used in the vicinity of strong signal sources. The LNA as well as all other components in the antenna are supplied by the connected receiver via the cable set, thus eliminating the need for batteries inside the R&S®HE400.

Geolocation and triangulation

The integrated electronic compass delivers exact azimuth and elevation data. Together with the sensitive GPS- and Glonass-capable receiver in the antenna handle, precise location accuracy is provided by triangulation.

Specifications in brief of the R&S®HE400

Frequency range	
HF antenna module	8.3 kHz to 30 MHz
VHF antenna module	20 MHz to 200 MHz
UWB antenna module	30 MHz to 6 GHz
Log-periodic antenna module	450 MHz to 8 GHz
Cellular antenna module	700 MHz to 2500 MHz
Polarization	adjustable, linear vertical or horizontal
VSWR	typ. < 2.5
RF output	N connector, male
Control and power supply	7 pin male (via R&S®PR100)
Operating weight	< 1 kg (grip piece with one module)

Specifications in brief

Specifications in brief		
RF data		
Frequency range		9 kHz to 7.5 GHz
RF input		
Impedance		50 Ω
Preselection		
	9 kHz to 30 MHz	30 MHz lowpass filter
	20 MHz to 1.5 GHz	tuned bandpass filters
	1.5 GHz to 7.5 GHz	highpass/lowpass filter combination
IF data		
IF spectrum display range		1 kHz to 10 MHz, 1/2/5/10/20/50/100/200/500 kHz, 1/2/5/10 MHz
Display modes		normal (clear/write), average, max. hold, min. hold
IF demodulation bandwidths	16 filters (specified values indicate 3 dB bandwidth)	150/300/60 Hz, 1.5/2.4/6/9/12/15/30/50/120/150/250/300/ 500 kHz
Demodulation modes		
	all demodulation bandwidths	AM, FM, pulse, I/Q
	demodulation bandwidth \leq 9 kHz	LSB
	demodulation bandwidth \leq 15 kHz	ISB
	demodulation bandwidth \leq 9 kHz	CW
Scan modes		
Frequency scan (FScan)		
	start and stop frequency, step width	user-selectable
	scan speed	up to 200 channels/s
Memory scan (MScan)		
	memory locations	1024, user-programmable
	scan speed	up to 150 channels/s
Panorama scan (PScan)		
	start and stop frequency	user-selectable
	resolution bandwidths (bin widths)	125/250/500/62 Hz, 1.25/2.5/3.125/6.25/12.5/25/50/100 kHz
	scan speed (RBW = 100 kHz, measurement time = 500 μ s, IF spectrum = normal, clear/write, display mode = IF spectrum)	up to 2 GHz/s
DF mode		
Frequency range		20 MHz to 6 GHz
DF method		
	with R&S®ADD207 or R&S®ADD307 DF antenna, or with R&S®ADD107 DF antenna above 173 MHz	correlative interferometer
	with R&S®ADD107 DF antenna below 173 MHz	Watson-Watt
Display resolution	selectable	0.1° or 1°

Ordering information

Designation	Type	Order No.
Base unit		
Portable Receiver IF spectrum (max. 10 MHz), spectrogram (waterfall display), 6-cell lithium-ion battery, plug-in power supply, SD card for storing user settings, shoulder strap	R&S®PR100	4079.9011.02
Documentation of Calibration Values	R&S®PR100-DCV	4071.9906.02
Software options		
Panorama Scan RF scan, high-speed FFT scan across user-selectable scan range, selectable spectral resolution (bin width)	R&S®PR100-PS	4071.9306.02
Internal Recording recording of measured data in the receiver (64 Mbyte RAM) or on SD card, recording of audio data in WAV format (replay using Windows Media Player, for example), recording of I/O data, spectra and spectrogram (waterfall) data, R&S®PR100-Control software for viewing measured data on customer PC	R&S®PR100-IR	4071.9358.02
Remote Control remote control of receiver via LAN interface (SCPI protocol); transfer of measured data via LAN interface; transfer of demodulated I/O data (up to 500 kHz bandwidth) via LAN interface; R&S®PR100-Control software (for remote control, data recording and data playback via PC)	R&S®PR100-RC	4071.9406.02
Externally Triggered Measurements an external sensor (not supplied with the receiver) triggers a measurement in the R&S®PR100; the sensor is connected via the AUX interface ¹⁾	R&S®PR100-ETM	4071.9458.02
Field Strength Measurement the field strength is calculated using antenna factors stored in the receiver; the receiver displays the field strength directly in dB μ V/m	R&S®PR100-FS	4071.9506.02
SHF Frequency Processing for downconverter antennas the downconverter unit of the R&S®HF907DC antenna is connected to the receiver via a control cable; the receiver recalculates the downconverted signals to display them with their original frequencies up to 18 GHz and with the sidebands in their original positions, thus relieving the user from having to convert signals subsequently (antenna and downconverter not supplied with the R&S®PR100-FP option)	R&S®PR100-FP	4071.9558.02
GPS Software Interface for data stream processing of external GPS module (GPS module not included in scope of delivery)	R&S®PR100-GPS	4071.9958.02
Direction Finder Upgrade Kit adds accurate direction finding functionality to the R&S®PR100 receiver (DF antennas and cable set not included)	R&S®PR100-DF	4096.2805.02
Polychrome Spectrum Display adds a color-coded spectrum display to indicate the relative signal occupancy	R&S®PR100-PC	4096.2828.02
Accessories		
Battery Pack 6-cell lithium-ion battery, charging cradle, plug-in power supply	R&S®PR100-BP	4071.9206.02
Suitcase Kit hard-shell transit case with headphones and telescopic antenna and extra space for accessories	R&S®PR100-SC	4071.9258.02
Vehicle Adapter	R&S®HA-Z202	1309.6117.00
Lithium-Ion Battery Pack, 6 Ah	R&S®HA-Z206	1309.6146.00
Carrying Holster chest strap and rainproof cover	R&S®HA-Z222	1309.6198.00
Carrying Bag soft carrying bag	R&S®HA-Z220	1309.6175.00
GPS Receiver external GPS receiver for the R&S®PR100	R&S®HA-Z240	1309.6700.03
Handheld Directional Antenna (antenna handle)	R&S®HE400	4104.6000.02
HF Antenna Module, 8.3 kHz to 30 MHz	R&S®HE400HF	4104.8002.02
VHF Antenna Module, 20 MHz to 200 MHz	R&S®HE400VHF	4104.8202.02
UWB Antenna Module, 30 MHz to 6 GHz	R&S®HE400UWB	4104.6900.02
Log-Periodic Antenna Module, 450 MHz to 8 GHz	R&S®HE400LP	4104.8402.02
Cellular Antenna Module, 700 MHz to 2500 MHz	R&S®HE400CEL	4104.7306.02
Cable Set for R&S®HE400 and R&S®PR100 or R&S®FSH	R&S®HE400-K	4104.7770.02
Transport Case for R&S®HE400	R&S®HE400Z1	4104.9009.02
Transport Bag (small) for R&S®HE400 (recommended for one or two antenna modules)	R&S®HE400Z2	4104.9050.02
Transport Bag (large) for R&S®HE400 (recommended for three or four antenna modules)	R&S®HE400Z3	4104.9080.02
Tripod for R&S®HE400	R&S®HE400Z4	4104.9109.02

Designation	Type	Order No.
SHF antenna and accessories		
SHF Downconverter, 7.5 GHz to 18 GHz	R&S®HF907DC	4070.8006.03
SHF Directional Antenna with Downconverter	R&S®HF907DC	4070.8006.04
Cable Set	R&S®HF907DC-K1	4070.8958.02
DF antennas and accessories		
Compact VHF/UHF DF Antenna	R&S®ADD107	4090.7005.02
Compact UHF/SHF DF Antenna	R&S®ADD207	4096.0002.02
Collapsible VHF/UHF DF Antenna	R&S®ADD307	4098.2002.07
Vehicle Adapter with Magnet Mount	R&S®ADD17XZ3	4090.8801.02
Cable Set with Converter	R&S®ADD17XZ5	4090.8660.02
Wooden Tripod	R&S®ADD17XZ6	4090.8860.02
Tripod Bag for R&S®ADD17XZ6	R&S®ADD17XZ7	4096.1450.02
DF Antenna Backpack, for R&S®DDF007, R&S®ADD107 or R&S®ADD207, R&S®ADD17XZ5 and R&S®ADD17XZ3	R&S®ADD17XZ8	4096.1580.02
Antenna Cable with Converter for R&S®ADD307, length: 5 m	R&S®ADD17XZ9	4098.3615.15
Extender Cable RF for R&S®DDF007 and R&S®PR100-DF	R&S®EXTCABLR	4096.1650.03
Extender Cable Control for R&S®DDF007 and R&S®PR100-DF	R&S®EXTCABLCTL	4096.1650.04
Extender Cable Set for R&S®DDF007 and R&S®PR100-DF	R&S®EXTCABLSET	4096.1650.02

¹⁾ Recommended options for R&S®HE400: externally triggered measurements, field strength measurements, GPS software interface.



R&S®HA-Z202 vehicle adapter.



R&S®HA-Z220 soft carrying bag.



R&S®HA-Z222 carrying holster incl. chest strap and rainproof cover.

Service options

Extended Warranty, one year	R&S®WE1	Please contact your local Rohde & Schwarz sales office.
Extended Warranty, two years	R&S®WE2	
Extended Warranty, three years	R&S®WE3	
Extended Warranty, four years	R&S®WE4	
Extended Warranty with Calibration Coverage, one year	R&S®CW1	
Extended Warranty with Calibration Coverage, two years	R&S®CW2	
Extended Warranty with Calibration Coverage, three years	R&S®CW3	
Extended Warranty with Calibration Coverage, four years	R&S®CW4	

R&S®PR100-BP battery pack, consisting of 6-cell lithium-ion battery, charging cradle and plug-in power supply.



R&S®PR100-SC suitcase kit, consisting of hardshell transit case (trolley case, with headphones and telescopic antenna and extra space for accessories).



4TECT

ООО «4ТЕСТ»

Телефон: +7 (499) 685-4444

info@4test.ru

www.4test.ru